

Surface Mount P-Channel Enhancement Mode MOSFET

(Pb) Lead(Pb)-Free

Features:

- * Super high dense
- * Cell design for low $R_{DS(ON)}$
- * $R_{DS(ON)} < 130\text{m}\Omega @ V_{GS} = -4.5\text{V}$
- * $R_{DS(ON)} < 180\text{m}\Omega @ V_{GS} = -2.5\text{V}$
- * Simple Drive Requirement
- * Lower On-resistance
- * Fast Switching

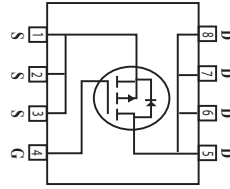

DRAIN CURRENT
-3.5 AMPERES
DRAIN SOURCE VOLTAGE
-20 VOLTAGE

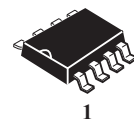

SOP-8

Description:

The WTK9431 provide the designer with the best combination of fast switching, ruggedized device design, low on-resistance and cost-effectiveness.

The SOP-8 package is universally preferred for all commercial-industrial surface mount applications and suited for low voltage applications such as DC/DC converters.

Maximum Ratings ($T_A = 25^\circ\text{C}$ Unless Otherwise Specified)

Rating	Symbol	Value	Unite
Drain-Source Voltage	V_{DS}	-20	V
Gate-Source Voltage	V_{GS}	± 8	V
Continuous Drain Current ⁽³⁾ <small>($T_A = 25^\circ\text{C}$) ($T_A = 70^\circ\text{C}$)</small>	I_D	-3.5 -2.8	A
Pulsed Drain Current ^(1,2)	I_{DM}	-18	A
Power Dissipation	P_D	2.5	W
Maximax Junction-to-Ambient	$R_{\theta JA}$	50	$^\circ\text{C/W}$
Operating Junction Temperature Range	T_J	+150	$^\circ\text{C}$
Storage Temperature Range	T_{stg}	-55 to +150	$^\circ\text{C}$

Device Marking

WTK9431=9431SC

Electrical Characteristics (T_A=25°C Unless otherwise noted)

Characteristic	Symbol	Min	Typ	Max	Unit
Static					
Drain-Source Breakdown Voltage V _{GS} =0V, I _D =-250 μA	V _{(BR)DSS}	-20	-	-	V
Gate-Source Threshold Voltage V _{DS} =V _{GS} , I _D =-250 μA	V _{GS(th)}	-0.4	-	-1.0	V
Gate-Source Leakage Current V _{DS} =0V, V _{GS} =±8V	I _{GSS}	-	-	±100	nA
Zero Gate Voltage Drain Current V _{DS} =-16V, V _{GS} =0V V _{DS} =-12V, V _{GS} =0V	I _{DSS}	-	-	-1 -25	μA
Drain-Source On-Resistance ⁽²⁾ V _{GS} =-10V, I _D =-5.3A V _{GS} =-4.5V, I _D =-4.2A	R _{DS(on)}	-	-	130 180	mΩ
Forward Transconductance ⁽²⁾ V _{DS} =-5V, I _D =-3.5A	g _{fs}	-	6.5	-	S

Dynamic

Input Capacitance V _{DS} =-10V, V _{GS} =0V, f=1MHZ	C _{iss}	-	405	-	pF
Output Capacitance V _{DS} =-10V, V _{GS} =0V, f=1MHZ	C _{oss}	-	170	-	
Reverse Transfer Capacitance V _{DS} =-10V, V _{GS} =0V, f=1MHZ	C _{rss}	-	45	-	

Switching

Turn-On Delay Time ⁽²⁾ V _{DD} = -5V, I _D = -1A, V _{GS} = -4.5V, R _G = 6Ω	t _{d(on)}	-	6.5	-	nS
Rise Time V _{DD} = -5V, I _D = -1A, V _{GS} = -4.5V, R _G = 6Ω	t _r	-	20	-	nS
Turn-Off Time V _{DD} = -5V, I _D = -1A, V _{GS} = -4.5V, R _G = 6Ω	t _{d(off)}	-	31	-	nS
Fall Time V _{DD} = -5V, I _D = -1A, V _{GS} = -4.5V, R _G = 6Ω	t _f	-	21	-	nS
Total Gate Charge ⁽²⁾ V _{DS} =-5V, I _D =-5.3A, V _{GS} =-4.5V	Q _g	-	6	8.5	nc
Gate-Source Charge V _{DS} =-5V, I _D =-5.3A, V _{GS} =-4.5V	Q _{gs}	-	0.8	-	nc
Gate-Drain Charge V _{DS} =-5V, I _D =-5.3A, V _{GS} =-4.5V	Q _{gd}	-	1.3	-	nc
Drain-Source Diode Forward Voltage ⁽²⁾ V _{GS} =0V, I _S =-2.1A	V _{SD}	-	-	-1.2	V
Continuous Source Current (Body Diode) V _D =V _G =0V, V _S =-1.2V	I _S	-	-	-2.1	A

Notes: 1. Pulse width limited by Max. junction temperature.

2. Pulse width 300μs, duty cycle ≤ 2%.

3. Surface mounted on 1 in² copper pad of FR4 board; 125°C/W when mounted on Min. copper pad.

Characteristics Curve

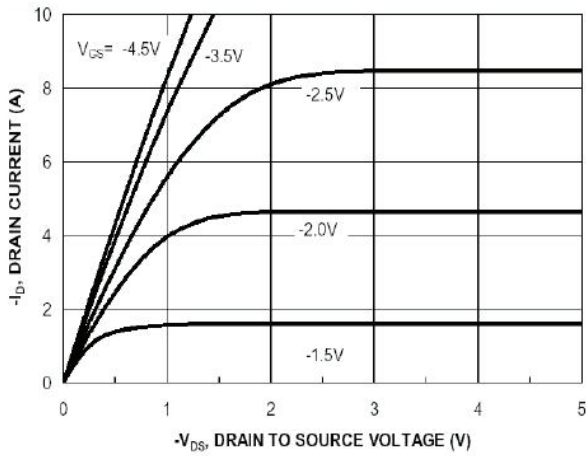

Fig 1. Typical Output Characteristics

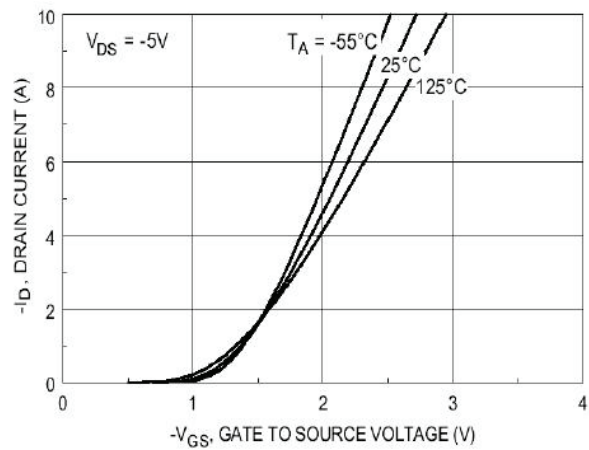

Fig 2. Transfer Characteristics

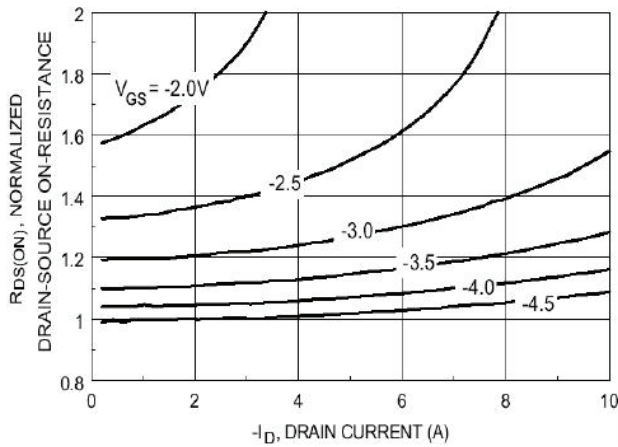

Fig 3. On-Resistance v.s. Drain Current and Gate Voltage

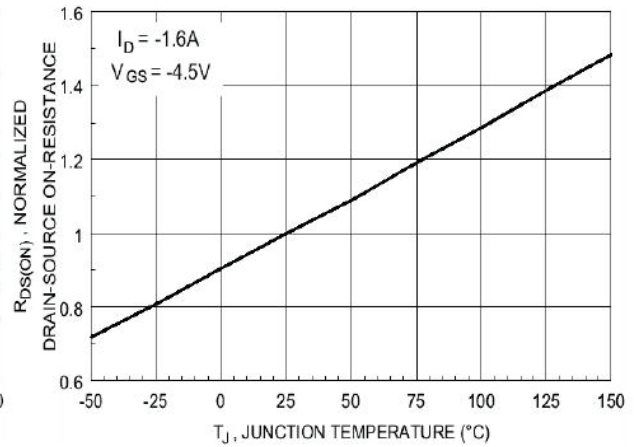

Fig 4. On-Resistance v.s. Junction Temperature

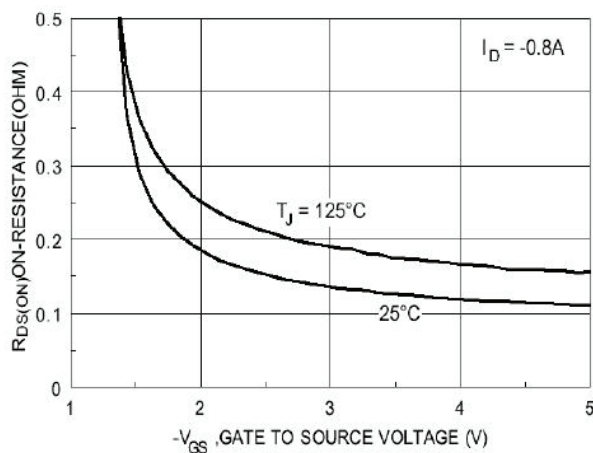

Fig 5. On-Resistance v.s. Gate-Source Voltage

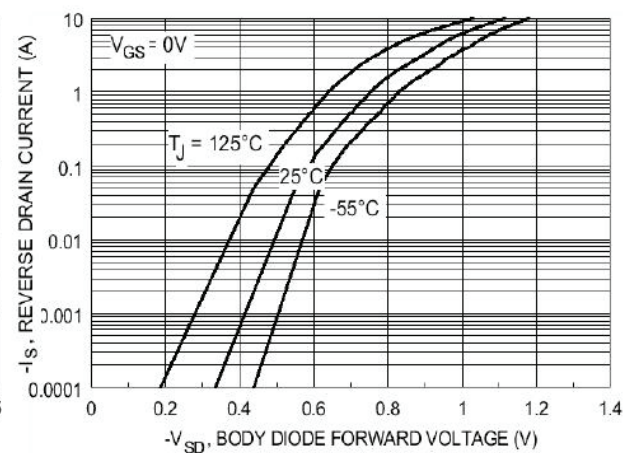

Fig 6. Body Diode Characteristics

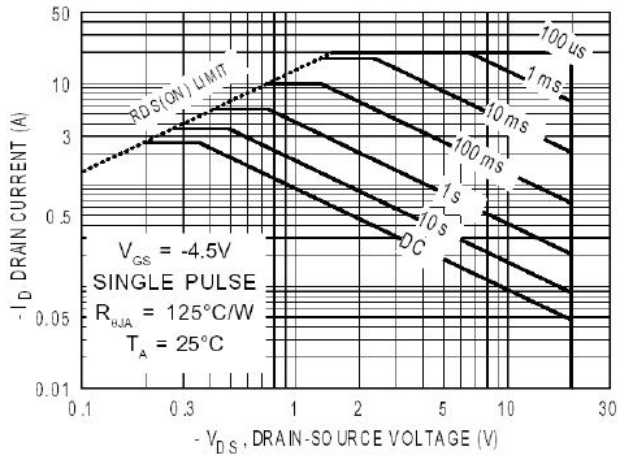

Fig 7. Maximum Safe Operating Area

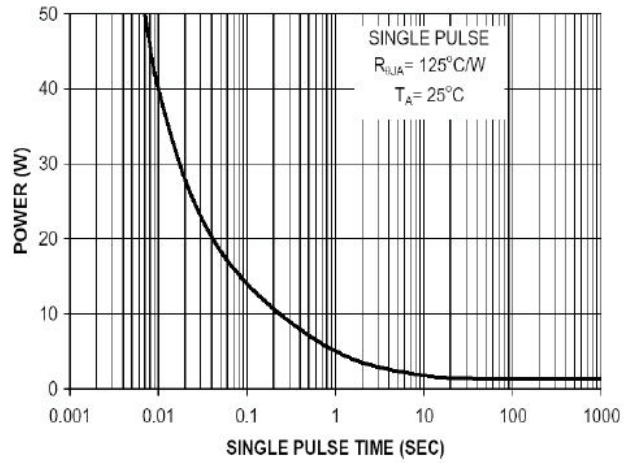

Fig 8. Single Pulse Maximum Power Dissipation

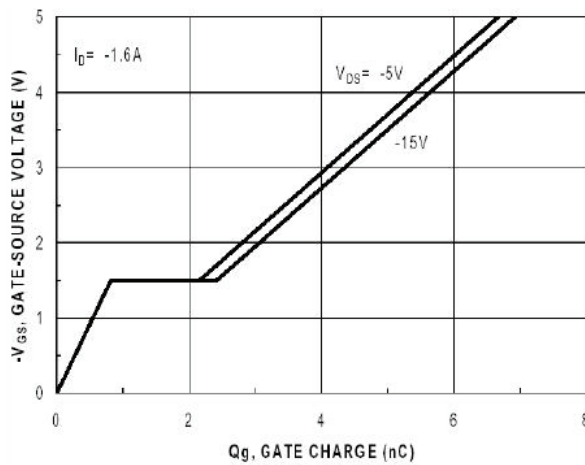

Fig 9. Gate Charge Characteristics

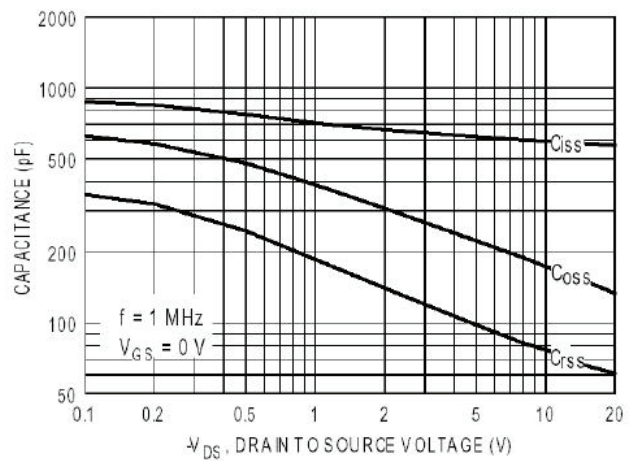

Fig 10. Typical Capacitance Characteristics

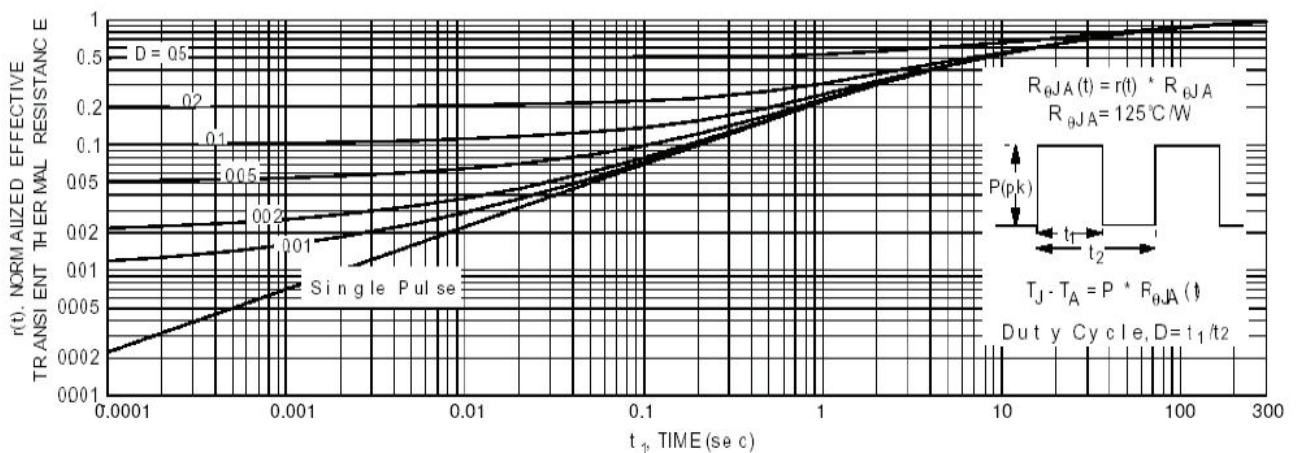
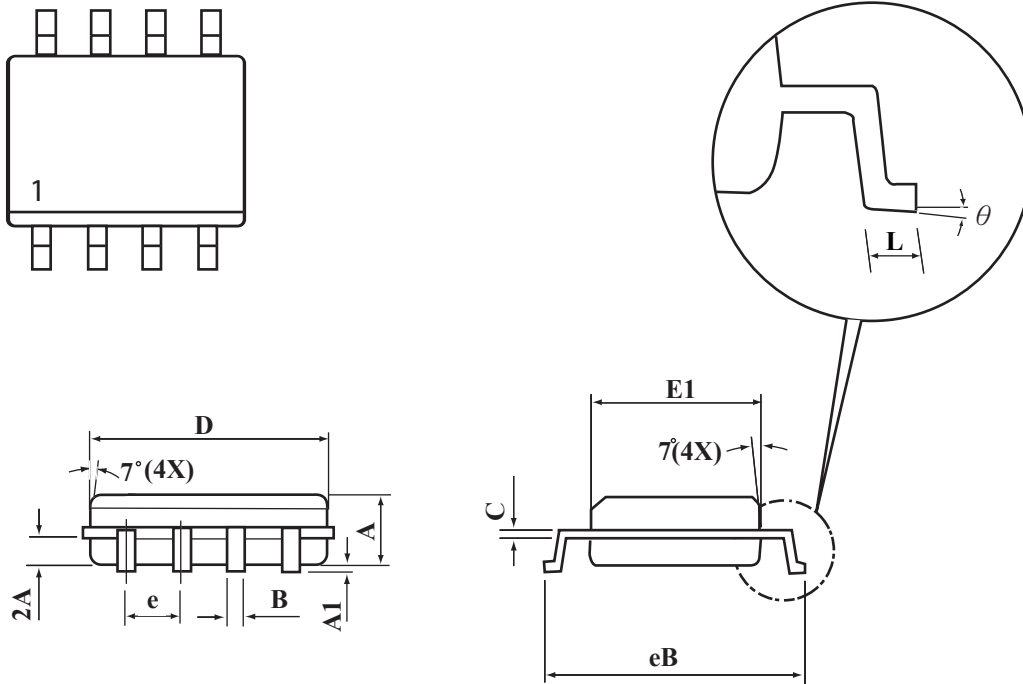

Fig 11. Transient Thermal Response Curve

SOP-8 Package Outline Dimensions

Unit:mm



SYMBOLS	MILLIMETERS	
	MIN	MAX
A	1.35	1.75
A1	0.10	0.20
B	0.35	0.45
C	0.18	0.23
D	4.69	4.98
E1	3.56	4.06
Be	5.70	6.30
e	1.27 BSC	
L	0.60	0.80
θ	0°	8°